

TURBO SURFACE

Product Images

APPLICATION AREAS:

Residential, Office buildings, Retail, Sports facilities, Studio, Stage, Supermarkets, Library



Dimming
Optional



RF Control



Smart Lighting



CCT Tuning



Google or
Alexa Voice

TECHNICAL SPECIFICATIONS

PRODUCT REFERENCE

ITEM CODE	TURBO SURFACE 85 20
ENVIRONMENT	Indoor
INSTALLATION	Surface

CONSTRUCTION AND MATERIALS

SIZE OUT SIDE MM	85 Dia x 140
CUT OUT SIZE (MM)	-
HOUSING	Extruded Aluminium
LENS / DIFFUSER	High Transmission PC
REFLECTOR	PC High Purity Metallised
SURFACE FINISH	White/Black/Custom Powder Coated
IP rating	20

THERMAL MANAGEMENT

HEAT SINK MATERIAL	Aluminium
COOLING TECHNIQUE	Passive

OPTICAL SYSTEM

BEAM ANGLE	24°, 36°, 60°
ILLUMINATION MODE	Direct Lighting
SWIVEL	No

LIGHT TECHNOLOGY

LED FITTED	Bridgelux
DELIVERED LUMENS	2300 / 2200 / 2100
CCT (K)	6000 / 4000 / 3000
Tunable	On Request
LED BINNING	3 Step MacAdam
CRI (Ra)	80 / 90
LED LIFE L70	40,000 HRS
LUMINAIRE	3200 / 3100 / 3000
LUMINOUS FLUX	
LUMINOUS EFFICACY	115 Lumens / Watt

ELECTRICAL SYSTEM

(UGR)	<20
INPUT VOLTAGE	220 TO 240 Vac
INPUT POWER	20W
POWER FACTOR	>0.95
THD	<10%
CONTROL GEAR	IN BUILT
MOUNTING	
DRIVER PROTECTION	OVP, Short Circuit, Surge
DIMMING	Phase / Analog / Dali / RF / APP
EMERGENCY	On Request
BATTERY BACKUP	

PACKAGING DETAILS

PACKING QTY -

GROSS WEIGHT -

CARTOON SIZE -
(LXBXH)

DIMENSIONS

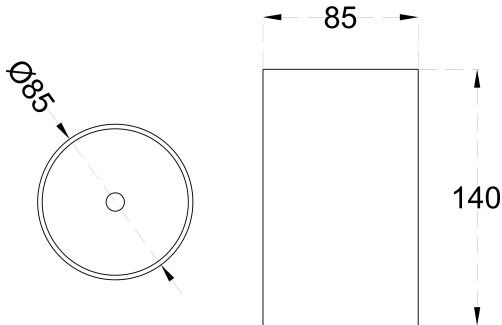

PHOTOMETRIC



ARCADE LIGHTING INDUSTRIES PVT LTD

8 Raju industrial estate, Penkar pada, Near
dahisar check naka, Mira road 401107

NOTE : The technical data sheet with design registration stamp is the property of Arcade Lighting India Pvt. Ltd. & protected under Intellectual Property law, and it is restricted for sharing with other lighting suppliers

Technical parameters are subjected to change time to time in order to improve product performance and reliability

BP-RV00 AR/FRT/TEC/TDS/01