

DONUT TRIMLESS

Product Images

APPLICATION AREAS:

Office buildings, Retail, Supermarkets, Hospitality, Libraries

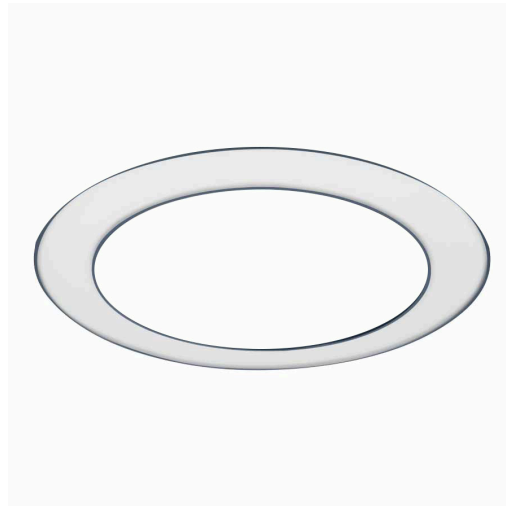

TECHNICAL SPECIFICATIONS

PRODUCT REFERENCE

ITEM CODE	DONUT TRIMLESS 60 900
ENVIRONMENT	Indoor
INSTALLATION	Trimless

CONSTRUCTION AND MATERIALS

SIZE OUT SIDE MM	900x90
CUT OUT SIZE (MM)	902x90
HOUSING	Extruded Aluminium
LENS / DIFFUSER	High Transmission PMMA
REFLECTOR	N/A
SURFACE FINISH	White/Black/Custom Powder Coated
IP rating	30

THERMAL MANAGEMENT

HEAT SINK MATERIAL	Aluminium
COOLING TECHNIQUE	Passive

OPTICAL SYSTEM

BEAM ANGLE	110°
ILLUMINATION MODE	Direct Lighting
SWIVEL	No

LIGHT TECHNOLOGY

LED FITTED	Bridgelux
DELIVERED LUMENS	6000 / 5700 / 5400
CCT (K)	6000 / 4000 / 3000
Tunable	On Request
LED BINNING	3 Step MacAdam
CRI (Ra)	80 / 90
LED LIFE L70	45,000 HRS
LUMINAIRE	8400 / 8100 / 7800
LUMINOUS FLUX	
LUMINOUS EFFICACY	100 Lumens / Watt

ELECTRICAL SYSTEM

(UGR)	<22
INPUT VOLTAGE	220 TO 240 Vac
INPUT POWER	60W
POWER FACTOR	>0.95
THD	<10%
CONTROL GEAR	Remote
MOUNTING	
DRIVER PROTECTION	OVP, Short Circuit, Surge
DIMMING	Phase / Analog / Dali / RF / APP
EMERGENCY BATTERY BACKUP	On Request

PACKAGING DETAILS

PACKING QTY 2

GROSS WEIGHT -

CARTOON SIZE 38"x38"x7.5"
(LXBXH)

DIMENSIONS

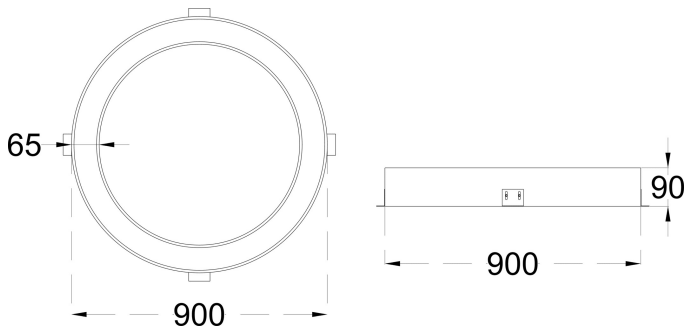

PHOTOMETRIC



ARCADE LIGHTING INDUSTRIES PVT LTD

8 Raju industrial estate, Penkar pada, Near
dahisar check naka, Mira road 401107

NOTE : The technical data sheet with design registration stamp is the property of Arcade Lighting India Pvt. Ltd. & protected under Intellectual Property law, and it is restricted for sharing with other lighting suppliers

Technical parameters are subjected to change time to time in order to improve product performance and reliability

BP-RV00 AR/FRT/TEC/TDS/01